

# ON-PREMISES RIGID MOUNT WASHER EXTRACTOR

PAN40

40lb

PAN  
RANGE



## FEATURES

- Rigid mounted, 100 or 200 G-Force options
- Stainless steel top, front, and side panels
- Stainless steel cylinder and tub
- Patented Cascade™ cylinder for better washability
- XControl+ – fully programmable control
- Patented soap hopper
- Large drain valve
- Front access to vital parts for easy maintenance
- Large door opening for easy loading and unloading
- USB plug on the back panel and control board
- Warranty: First three years on all parts; First five years frame and cylinder shaft assembly; First five years on cylinder bearings and bearing seals (parts only)

## OPTIONS

- Third water inlet
- Steam heating

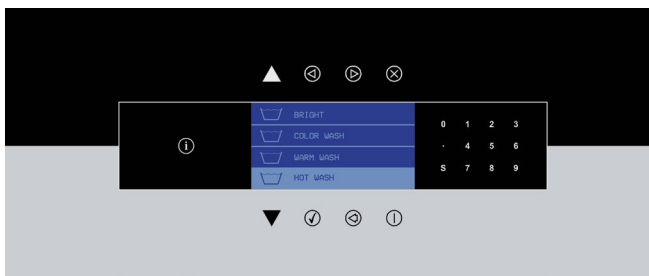

ERGONOMICAL  
CONSTRUCTION



LARGE DOOR  
OPENING



LOW WATER  
AND ENERGY  
CONSUMPTION



3 YEAR PARTS  
WARRANTY

**Coinamatic™**  
Commercial Laundry • CCL

*Ideas for the future. Answers for today.®*

1.877.755.5302 | [www.coinamatic.com](http://www.coinamatic.com)

MODEL		PAN40
CONTROL OPTION		XControl+
CAPACITY - lb (kg)		40 (18)
OVERALL WIDTH - in (mm)		35.03 (890)
OVERALL DEPTH - in (mm)		36.02 (915)
OVERALL HEIGHT - in (mm)		55.51 (1410)
CYLINDER DIAMETER - in (mm)		29.53 (750)
CYLINDER VOLUME - cu. ft (liters)		6.4 (181)
DOOR OPENING SIZE - in (mm)		18.11 (460)
DOOR BOTTOM TO FLOOR - in (mm)		18.31 (465)
WASH SPEED - RPM		42
EXTRACT SPEED - RPM		490/690
EXTRACT G-FORCE		100 or 200
STEAM HEATING - psi		15-116
SOUND PRESSURE LEVEL - dB (A)		< 65
WATER VALVE CONNECTION - NPT*		0.75"
WATER PRESSURE -psi		15-116
RECOMMENDED WATER PRESSURE - psi		44-73
WATER INLET (EACH) - g/min		5.28
DRAIN VALVE - in (mm)		3 (76)
FLOW AMOUNT W/ DRAIN VALVE - g/min		55.48
FLOOR TO DRAIN OUTLET CENTER - in (mm)		5.12 (130)
SIDE TO DRAIN OUTLET CENTER - in (mm)		11.02 (280)
STEAM VALVE CONNECTION - BSP		0.5"
VOLTAGE/CIRCUIT BREAKER - FLA	208-240/60/1	15-9.1
SHIPPING DIMENSIONS	APPROX. - in (mm)	
	Width	36.42 (925)
	Depth	38.19 (970)
	Height	61.02 (1550)
NET WEIGHT - lb (kg)	100/200	563/695 (255/315)
SHIPPING WEIGHT - lb (kg)	100/200	595/739 (270/335)
AGENCY APPROVALS		cCSAus

\*Fill hoses provided to convert BSP at machine to NPT supply connection.

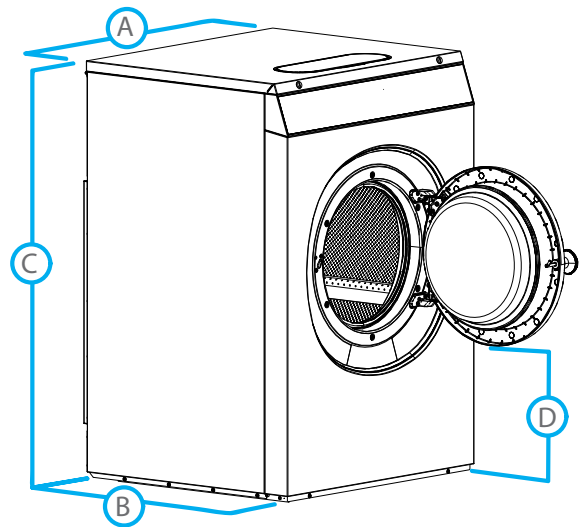

DIMENSIONS		PAN40
A.	OVERALL WIDTH - in (mm)	35.03 (890)
B.	OVERALL DEPTH - in (mm)	36.02 (915)
C.	OVERALL HEIGHT - in (mm)	55.51 (1410)
D.	DOOR BOTTOM TO FLOOR - in (mm)	18.31 (465)