

MANUAL HOMESTYLE

COMMERCIAL REAR CONTROL SINGLE DRYER – CANADA

Built for Reliable Performance

Huebsch®'s manual control single load dryer combines heavy-duty construction with reliable operation proven to stand the test of time. They're designed with less moving parts for one reason: so you'll face fewer maintenance problems and less wear and tear down the road. Our cabinet design maintains the perfect balance of heat, airflow and tumble action for optimal performance and efficiency. The equipment provides an advantage on such issues as energy conservation, equipment breakdowns and vandalism. Customers have the flexibility to choose from four heat/cycle selections.

- Industry's largest door opening 2.06 sq. ft. (1914 cm²)
- Door is reversible for installation flexibility
- High efficiency exhaust blower with superior airflow 220 cfm (105 liters/sec)
- 100% serviceable from the front
- Space-saving narrow cabinet 26.875" (683 mm)
- Upfront lint filter easy to clean and secured
- Durable galvanized steel cylinder
- Efficient and fast dry cycle
- Extra-large capacity

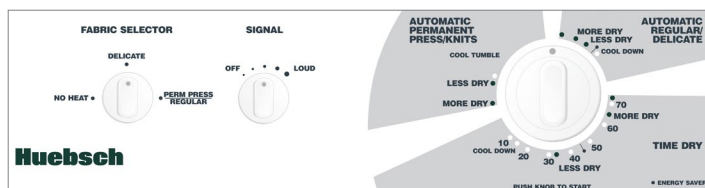

Manual homestyle control offers a reliable heavy-duty multi-cycle timer knob.

SPECIFICATIONS

COMMERCIAL REAR CONTROL SINGLE DRYER – CANADA

MODEL - see below for all models and activation available	
CONTROL OPTION	Manual Homestyle
COLOR	White
CAPACITY - lb (kg)	18 (8.2)
CYLINDER VOLUME - cu. ft. (liters)	7.0 (198)
MOTOR (THERMAL PROTECTED)	0.33 HP
TYPE OF GAS (GAS MODELS ONLY)	Factory equipped natural/mixed gas
AIR OUTLET DIAMETER - in (mm)	4 (102)
EXHAUST AIRFLOW - cfm (liters/sec)	220 (105)
AVAILABLE CYCLES	Automatic Permanent Press/Knits, Automatic Regular/Delicate, Time Dry
ELECTRICAL REQUIREMENTS	■ Electric 120/240/60/1-30 amp 120/208/240/60/1-30 amp
	Gas 120/60/1-15 amp
HEATING ELEMENT	Electric 5000W, 240V
	Gas 22,500 Btu
NET WEIGHT - lb (kg)	Electric 130 (59)
	Gas 132 (59.9)
SHIPPING WEIGHT lb (kg)	Electric 140 (63.5)
	Gas 141.5 (64.2)
SHIPPING DIMENSIONS APPROX. - in (mm)	Width 30.5 (775)
	Depth 29.5 (762)
	Height 45 (1143)
AGENCY APPROVALS	Electric cULus
	Gas cCSAus

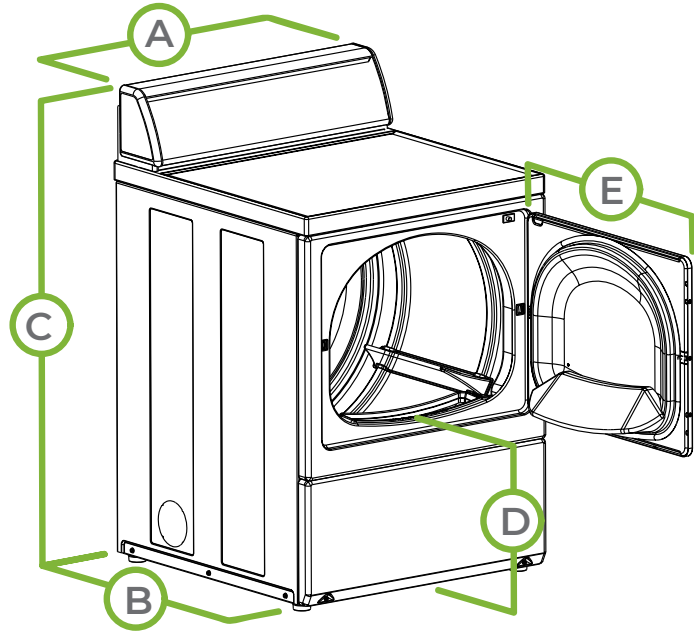

A. OVERALL WIDTH - in (mm)	26.875 (683)
B. OVERALL DEPTH - in (mm)	28 (711)
C. OVERALL HEIGHT - in (mm)	43 (1092)
D. FLOOR TO DOOR OPENING -in (mm)	15.44 (392)
E. DOOR SWING - in (mm)	23.5 (597)

MODELS	VOLTAGE/FREQ/PH	
YDE3TRGS171CW01	120/240/60/1	Electric
YDG3TRGS115CW01	120/60/1	Gas

■ Gas dryers can be field converted for operation on LP gas with optional 458P3 conversion kit.

For the most accurate information, the installation guide should be used for all design and construction purposes. Due to continuous product improvements, design and specifications subject to change without notice. The quality management systems at Alliance Laundry Systems are registered to ISO 9001.